

# nVent CADDY Cat HP J-Hook Tree, Flange Mount, Single Sided, 2" dia, 3 Tier

## Data Solutions

### CATALOG NUMBER

---

**CAT32HPSFM3**



### FEATURES

---

Easy installation to beam flanges

Provides optimal support for high-performance data cable, up to and including Cat 5e, Cat 6, Cat 6A, Cat 7 and fibre optic

Ready to use out of the box, saving installation time and labor

Requires no screws, rivets or special tools for assembly

Single- or double-sided tree configurations provide multiple J-Hooks with one structural attachment

Provides superior fill capacity and load rating over most other non-continuous cable support alternatives

Complies with EN 50174-2

Meets ISO®/IEC 14763-2, ANSI®/TIA 568 and ANSI®/TIA 569

### PRODUCT ATTRIBUTES

---

Material: Steel

Finish: Pregalvanized

Type: Single Sided

Diameter (Ø): 50mm

Tiers: 3

Flange Thickness (FT): 20.6mm max

Height (H): 387mm

Width (W): 84.8mm

A: 28.5mm

B: 50mm

Torque (TQ): 7N·m

Static Load: 800N

## ADDITIONAL PRODUCT DETAILS

---

Static loads represent maximum load limit of J-Hook tree. Static load limit of each J-Hook is 60 lb (270 N).

Setscrew must be tightened and torqued onto the sloped side of the I-beam.

Non-continuous supports may not exceed spacing of 5' (1.5 m) per TIA 569-C.9.7 and EN 50174-2.

## DIAGRAMS

---

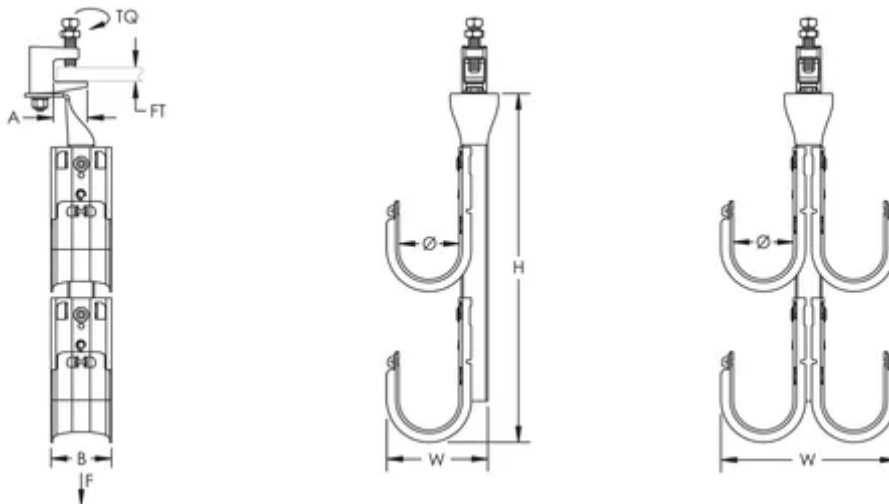

## WARNING

---

nVent products shall be installed and used only as indicated in nVent's product instruction sheets and training materials. Instruction sheets are available at [www.nvent.com](http://www.nvent.com) and from your nVent customer service representative. Improper installation, misuse, misapplication or other failure to completely follow nVent's instructions and warnings may cause product malfunction, property damage, serious bodily injury and death and/or void your warranty.



Our powerful portfolio of brands:

**CADDY ERICO HOFFMAN ILSCO SCHROFF TRACHTE**