

# HD NI Heavy Duty Pipe Clamp, Fire/Sprinkler, EG, 199–205 mm OD, M12, M16 Rod

## CATALOG NUMBER

**HDN205**



## CERTIFICATIONS



## FEATURES

Fillet welded connector nut has flats to accommodate spanners

## PRODUCT ATTRIBUTES

Article Number: 577026

Nut Included: Yes

Material: Steel

Finish: Electrogalvanized

Outer Diameter (OD): 199 - 205 mm

Rod Size (RS): M12;M16

Width (W): 40 mm

Thickness (T): 4 mm

Screw Diameter (Sc): 10 mm

Screw Diameter metric (Sc): M10

Screw Length (L): 40mm

Static Load: 8500N

## DIAGRAMS

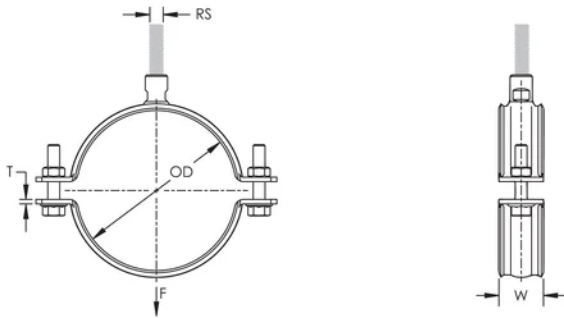

## WARNING

nVent products shall be installed and used only as indicated in nVent's product instruction sheets and training materials. Instruction sheets are available at [www.nvent.com](http://www.nvent.com) and from your nVent customer service representative. Improper installation, misuse, misapplication or other failure to completely follow nVent's instructions and warnings may cause product malfunction, property damage, serious bodily injury and death and/or void your warranty.

### North America

+1.800.753.9221

Option 1 – Customer Care

Option 2 – Technical

Support

### Europe

Netherlands:

+31 800-0200135

France:

+33 800 901 793

### Europe

Germany:

800 1890272

Other Countries:

+31 13 5835404

### APAC

Shanghai:

+ 86 21 2412 1618/19

Sydney:

+61 2 9751 8500



Our powerful portfolio of brands:

CADDY

ERICO

HOFFMAN

ILSCO

SCHROFF

TRACHTE

