

Cable Eye, Plastic, 30W 55D

Data Solutions

CATALOG NUMBER

60118-458

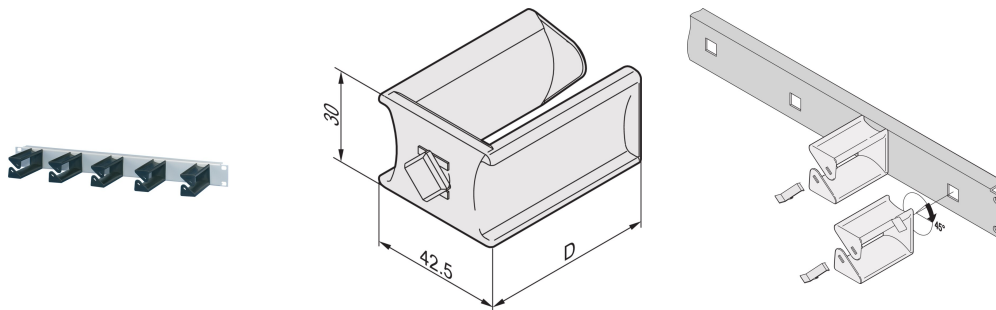

Simple to fit cable eyes into 19" front panel for cable eyes.

CERTIFICATIONS



FEATURES

Simple to fit cable eyes into 19" front panel for cable eyes. Insert cable eyes into frontpanel and rotate them 45°

PRODUCT ATTRIBUTES

Material: Polyamide

Package Quantity: 5

Color: Black

Product Type: Cable Eye

Works With: Varistar CP

Cable Type: Single

Net Weight: 0.1kg

DIAGRAMS

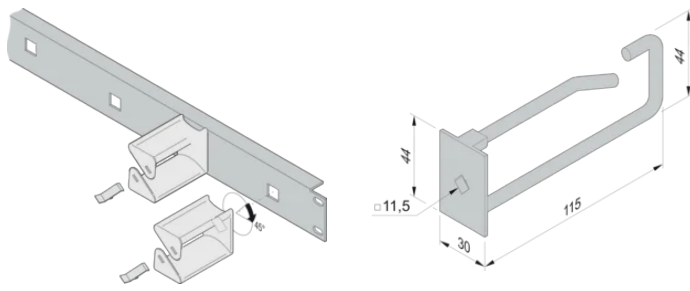

WARNING

nVent products shall be installed and used only as indicated in nVent's product instruction sheets and training materials. Instruction sheets are available at www.nvent.com and from your nVent customer service representative. Improper installation, misuse, misapplication or other failure to completely follow nVent's instructions and warnings may cause product malfunction, property damage, serious bodily injury and death and/or void your warranty.



Our powerful portfolio of brands:

CADDY ERICO HOFFMAN ILSCO SCHROFF TRACHTE