

1 U Air Deflector for 19" Fan Tray, 6 Fans, Front Solid, 330 mm, RAL 9006

NUMĂR DE CATALOG

10713-151

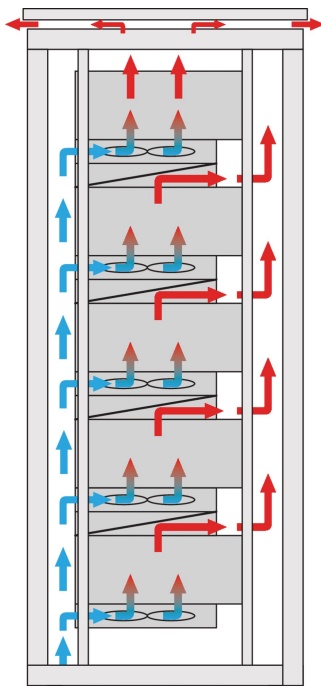
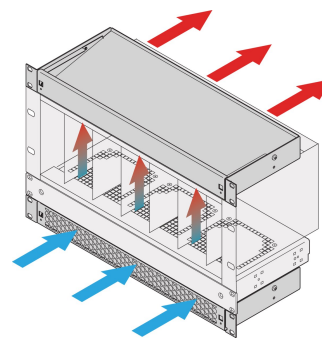

Air deflector with 1 U height to guide the air from front to top or from bottom to rear.

CERTIFICATIONS



CARACTERISTICI

Assembly options: – One fan tray: cool air is drawn in from the front and guided upwards – Two fan trays: cool air is drawn in from the front, directed upwards and guided to the rear (see application diagram)

Optimised cooling together with 19" fan trays

Vertical buildup of heat is avoided via improved airflow

Optional filter mat, simple to swap during operation

ATTRIBUTE PRODUS

Product Type: Air Guide

Product Family: Novastar; Varistar

Works With: 19" Fan Trays

Finish: Vopsit Pulbere

Material: Oțel

Net Weight: 1.87kg

Package Quantity: 1

AVERTIZARE

Produsele nVent trebuie instalate și utilizate numai așa cum este indicat în fișele de instrucțiuni și materialele de formare ale nVent. Fișele de instrucțiuni sunt disponibile pe www.nvent.com și de la reprezentantul dvs. de servicii clienți nVent. O instalare incorectă, o utilizare abuzivă, o aplicare greșită sau orice altă lipsă de respectare completă a instrucțiunilor și avertismentelor nVent poate duce la defectarea produsului, la deteriorarea proprietății, la răniri corporale grave și moarte și/sau poate anula garanția dvs.

North America

All locations
+1.763.422.2661
Chat with us:
nvent.com/schroff

Europe

Straubenhardt, Germany
+49.7082.794.0
Betschdorf, France
+33.3.88.90.64.90
Warsaw, Poland
+48.22.209.98.35
Assago, Italy
+39.02.932.7141
Chat with us:
nvent.com/schroff

Asia

Shanghai, China
+86.21.2412.6943
Qingdao, China
+86.532.8771.6101
Singapore
+65.6768.5800
Shin-Yokohama, Japan
+81.45.476.0271
Chat with us:
nvent.com/schroff

Middle East & India

Dubai, United Arab
Emirates
+971.4.378.1700
Bangalore, India
+91.80.6715.2001
Istanbul, Turkey
+90.216.250.7374
Chat with us:
nvent.com/schroff



Portofoliul nostru puternic de mărci:

CADDY ERICO HOFFMAN ILSCO SCHROFF TRACHTE